

1	2	3	4
5	6	7	8

貼り合わせ図

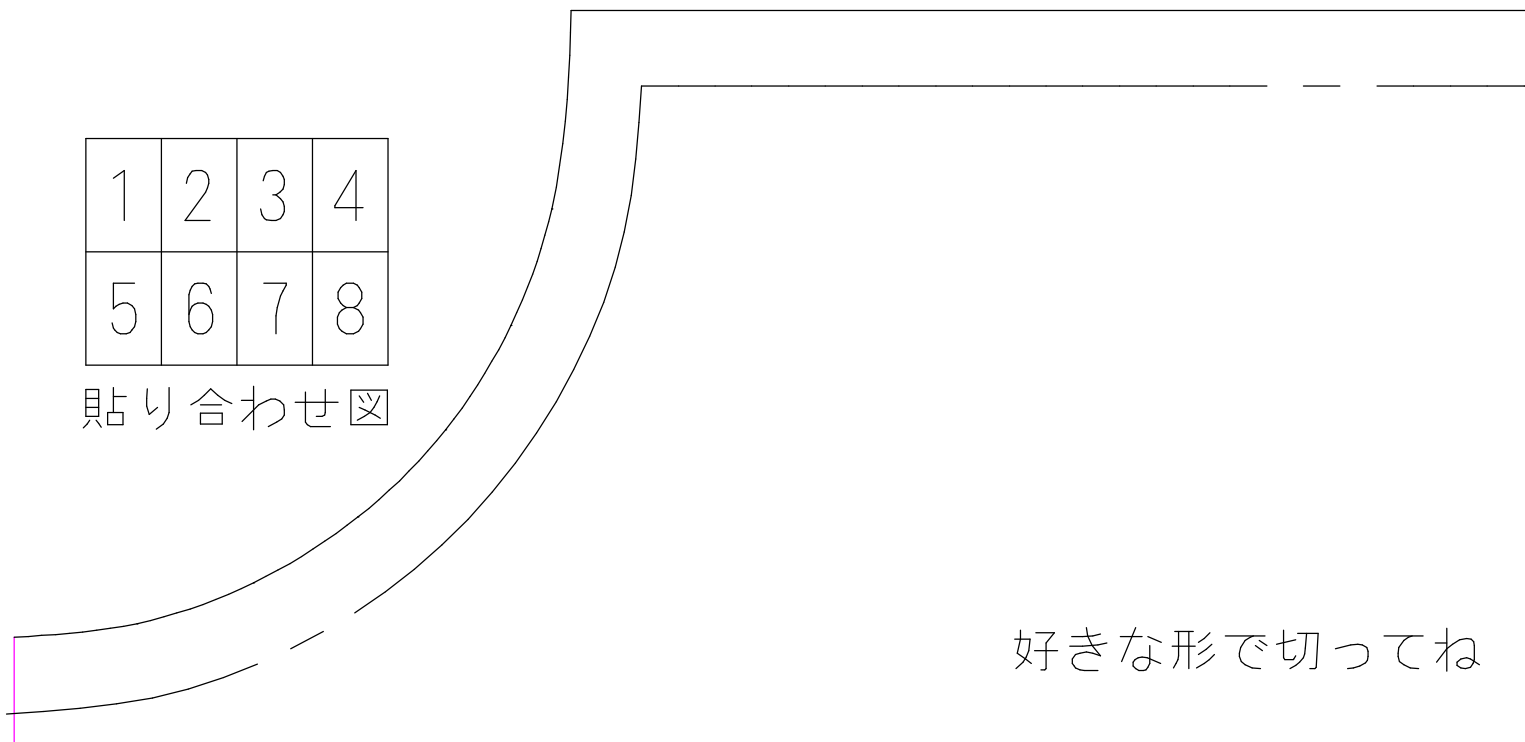

好きな形で切ってね

@

青の線で切ると短めの姫そで  
下に長めのそでを重ねてみたり  
長めのレースをつけてもいいね

←このラインを折り山にあわせ、左右対称に裁断する

赤い線で切るとスカラップそで  
そで口が波型でとってもかわいい

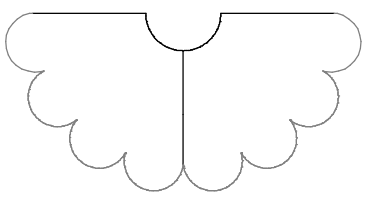
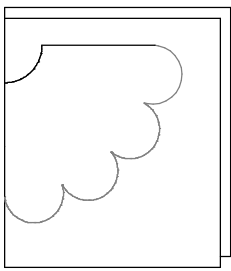

水色の線で切ると長めの姫そで

広げると左右対称になります

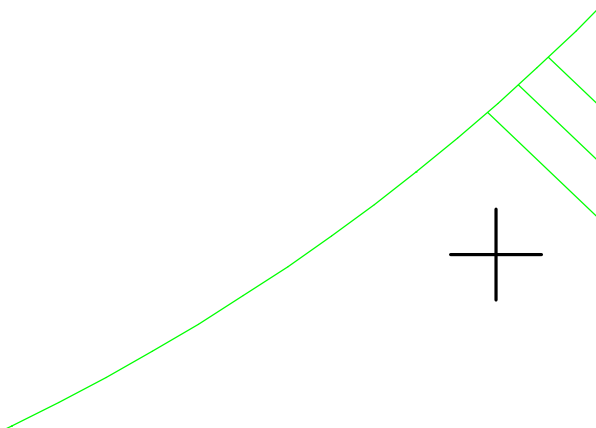
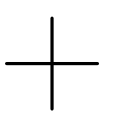
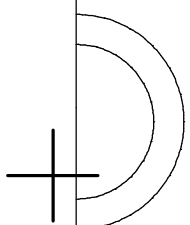

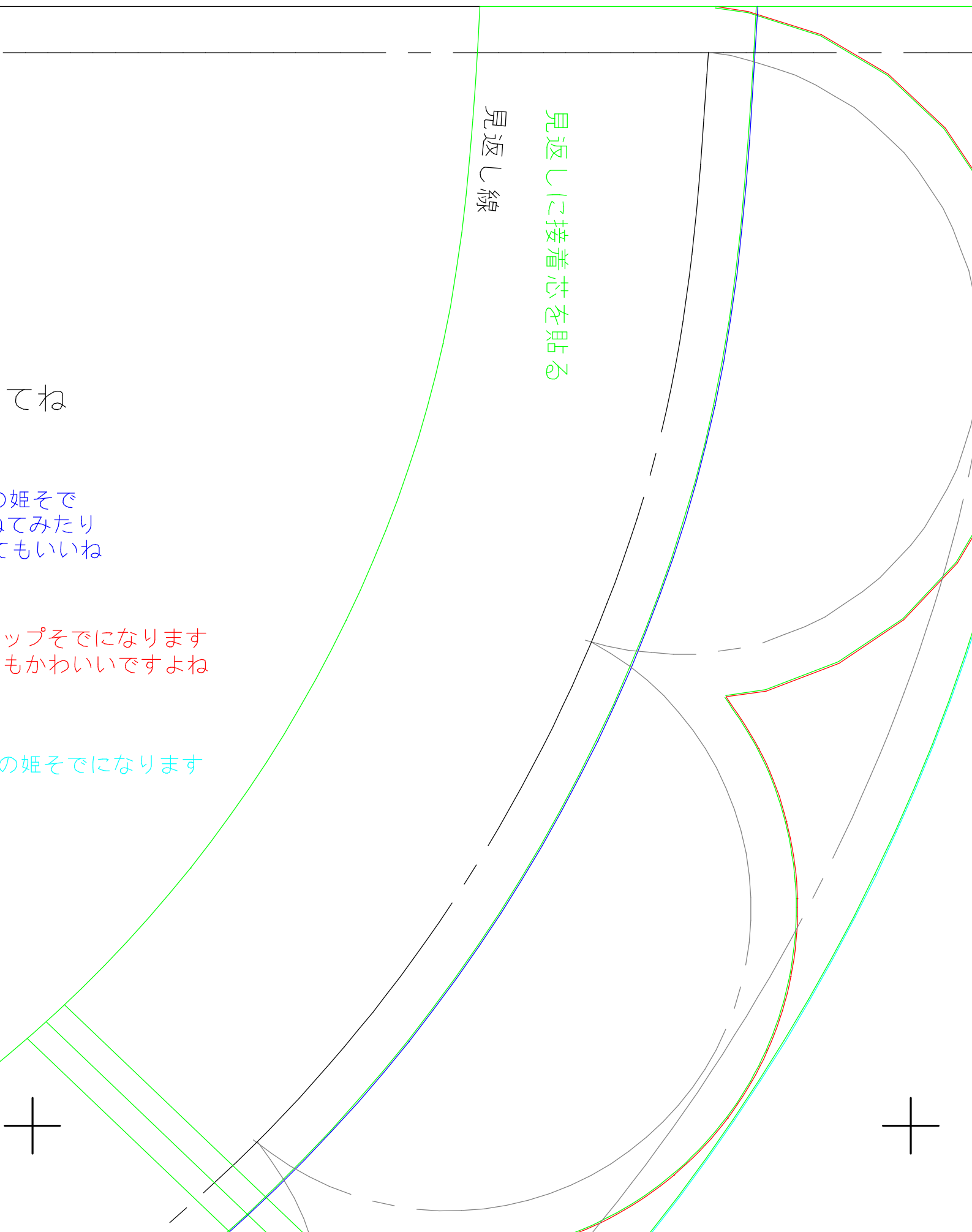
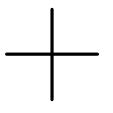
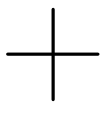

見返し線

見返しに接着芯を貼る

てね

の姫そで  
なてみたり  
にもいいね

ップそでになります  
もかわいいですよ

の姫そでになります

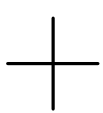

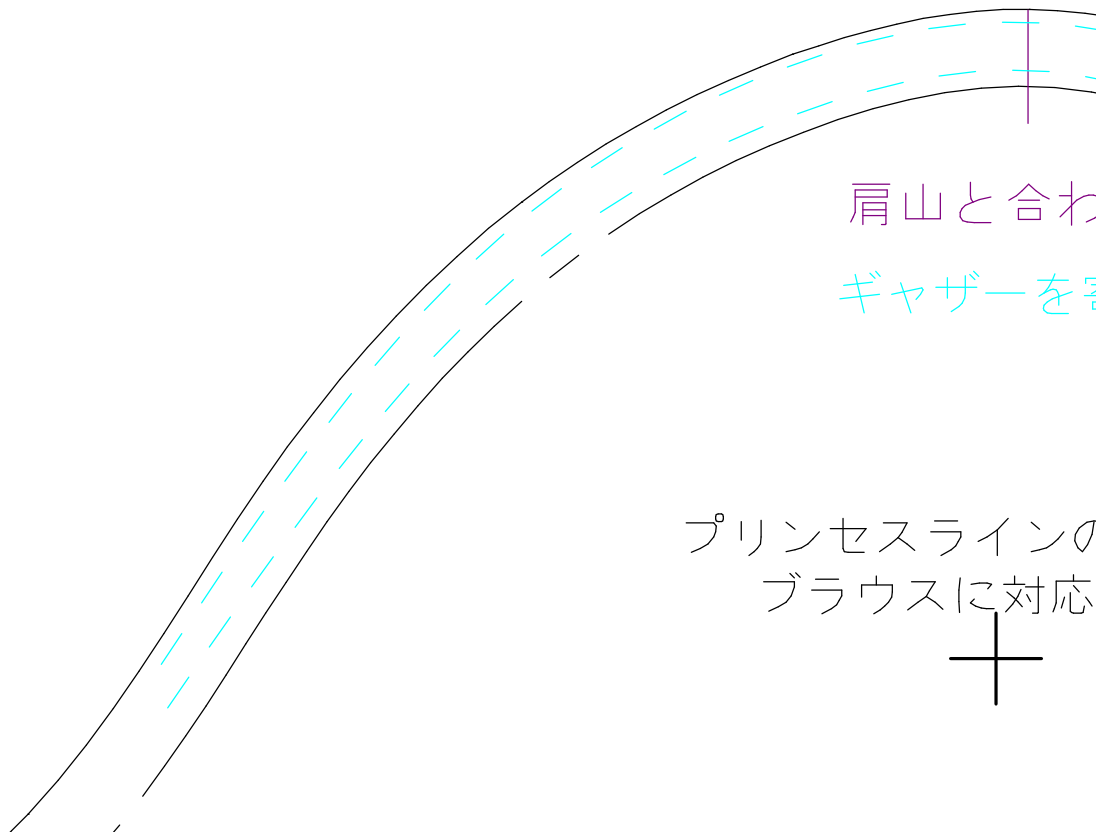
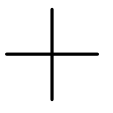
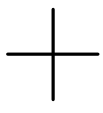

肩山と合わせ  
ギャザーを寄

プリンセスラインの  
ブラウスに対応

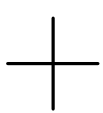

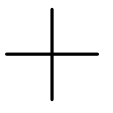
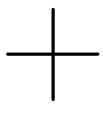

10分の1サイズ

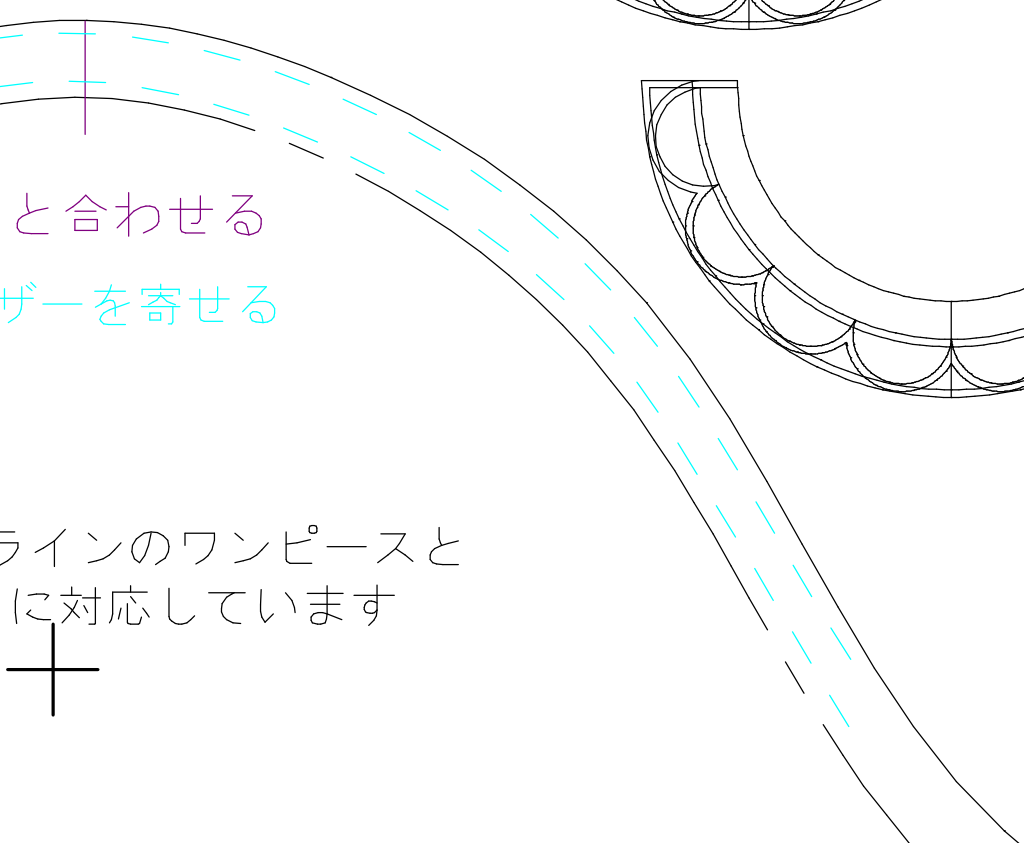
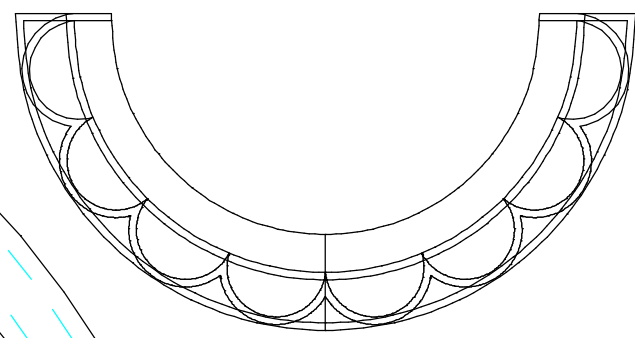
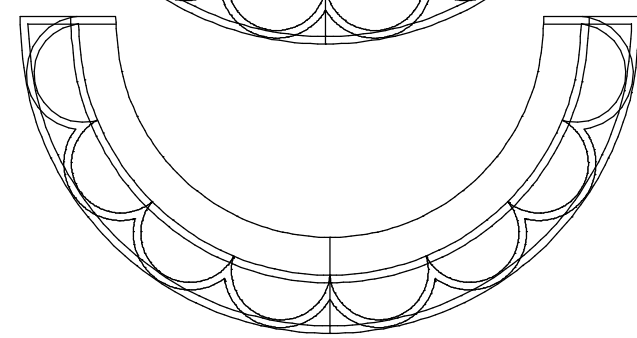
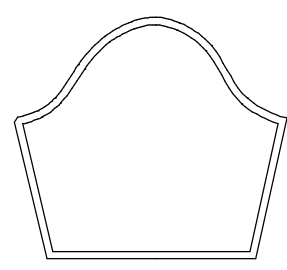
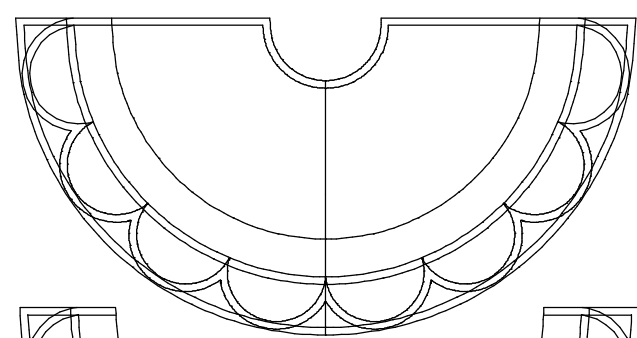
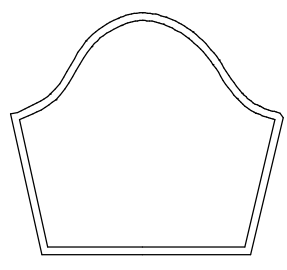
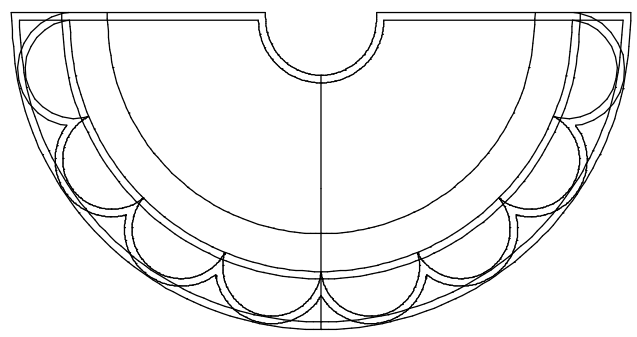

と合わせる  
ザーを寄せる

ラインのワンピースと  
に対応しています

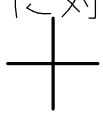

< 5 >

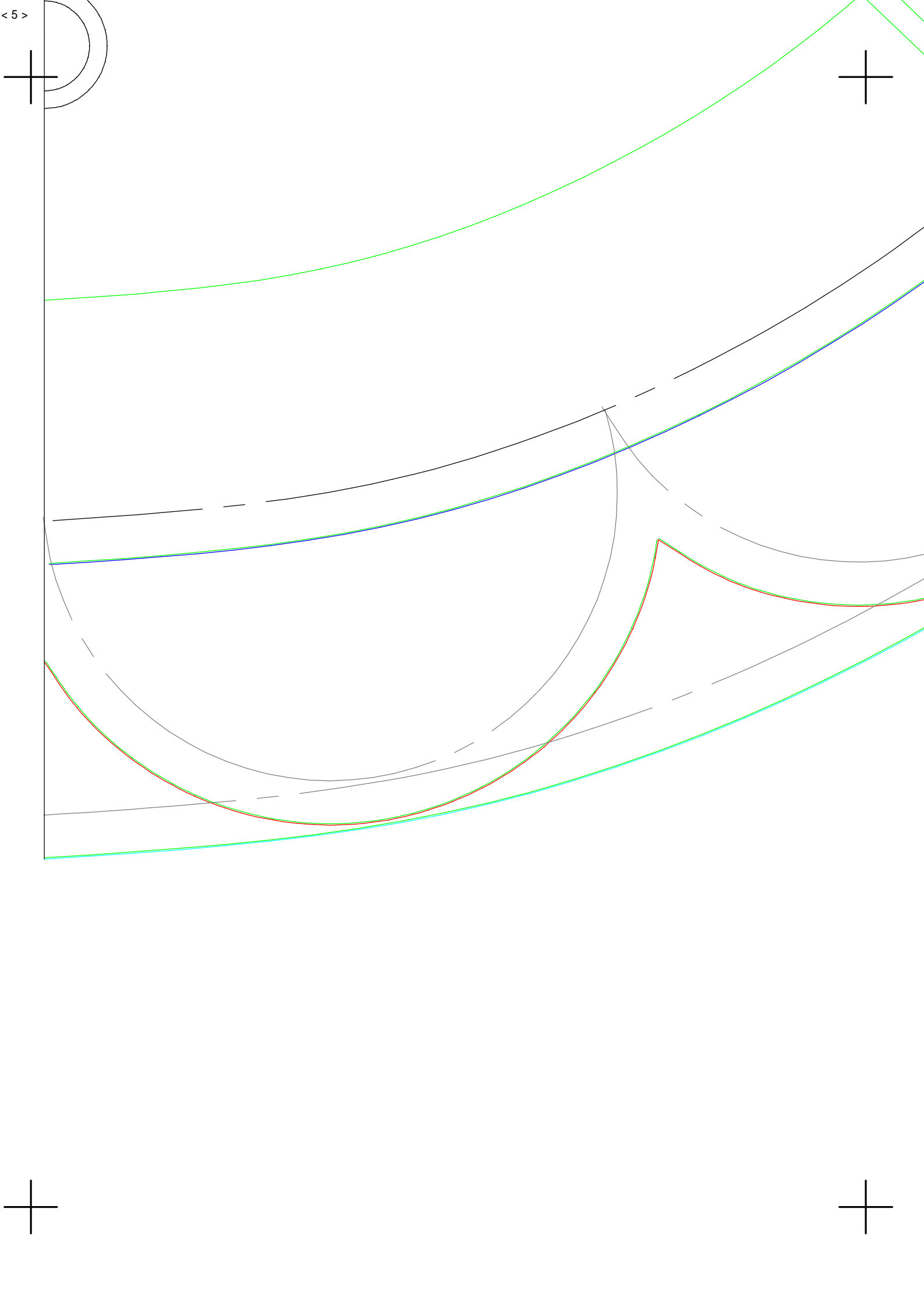

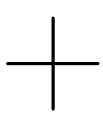
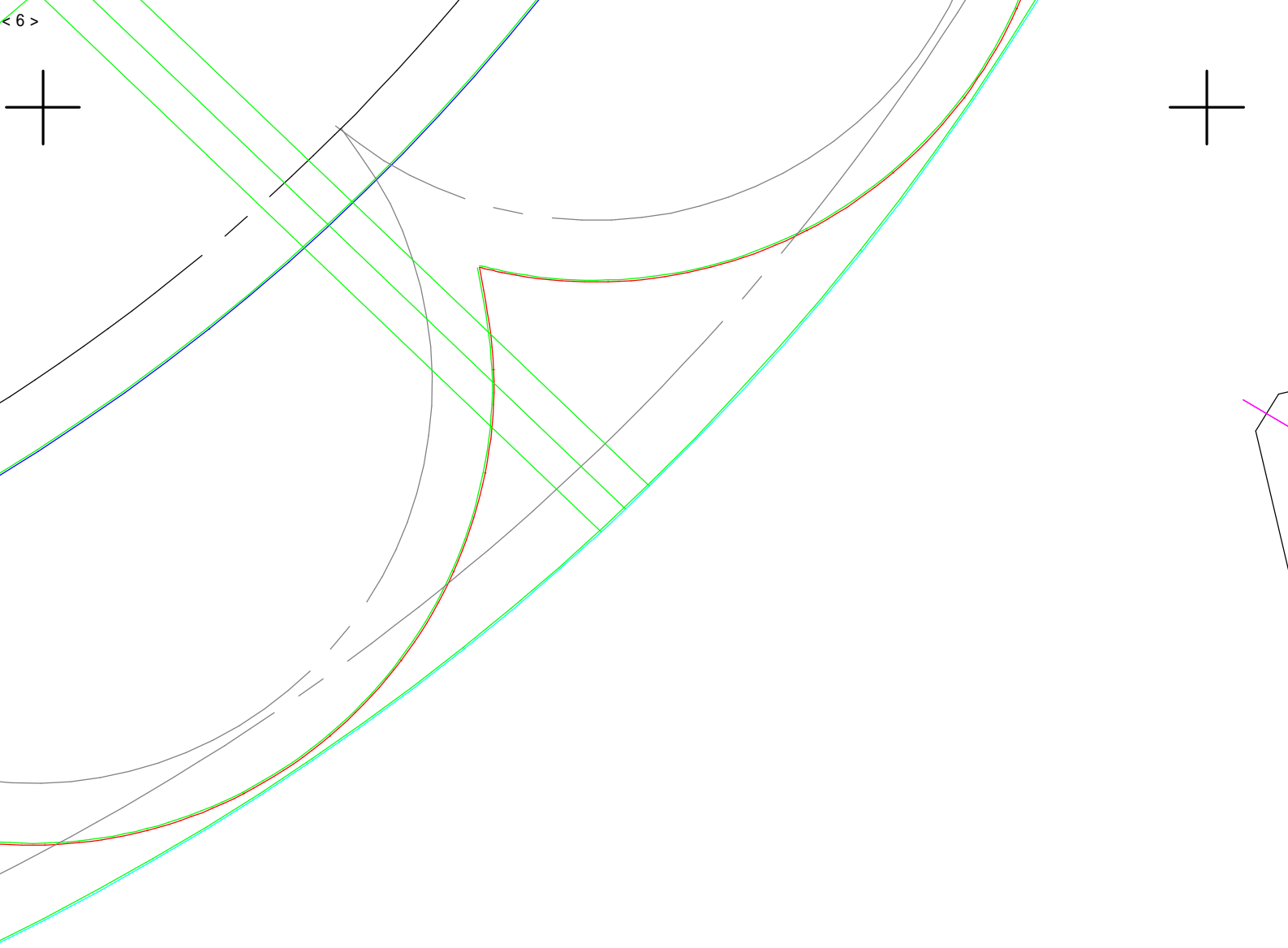
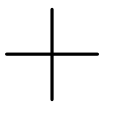
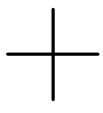

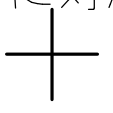
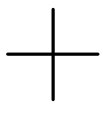

# スカラップ

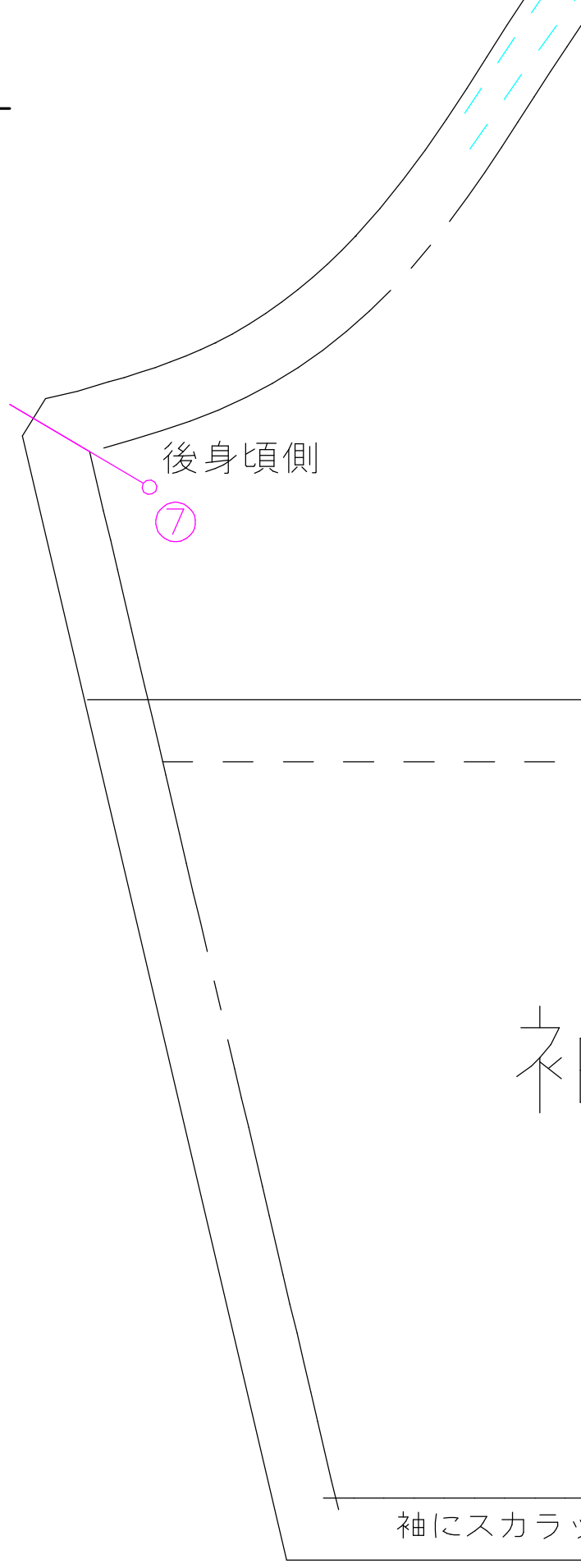

後身頃側

⑦

↓パフスリーブの縫い付け位置

↓パフスリーブをつける場合

袖

手作り服

@

袖にスカラップをつける

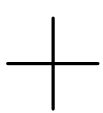

28のラインヒースと  
に対応しています

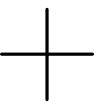

アップ用そで

前身頃側

⑥

の縫い代はここに合わせる↓

する場合はここをぬい合わせる↓

作り服の作りかたと型紙USAKOの洋裁工房

@

<http://yousai.net/>

