

1	2	3	4
5	6	7	8

貼り合わせ図

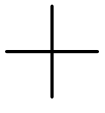

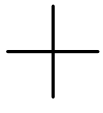
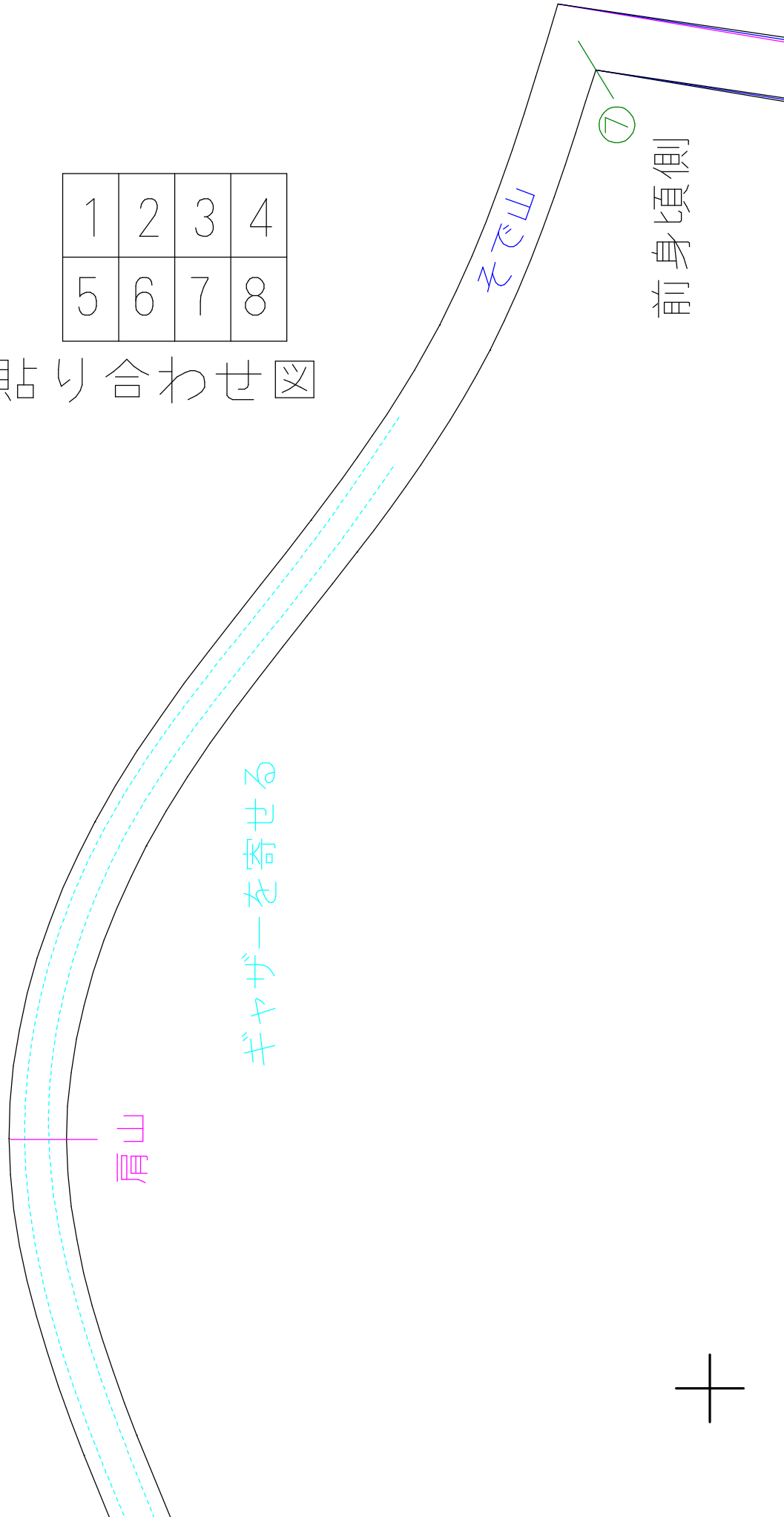
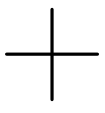
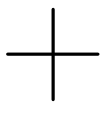

副券印刷

セーラー服

2枚

婦人Mサイズ

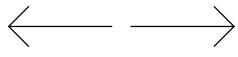

長さで1

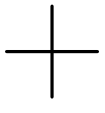
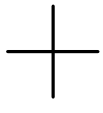

そで底

5

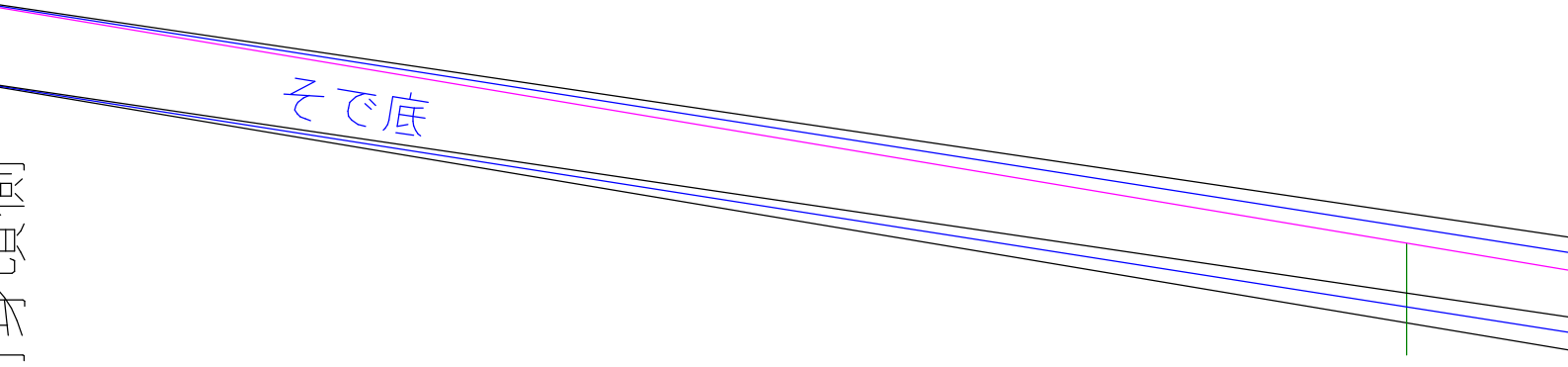

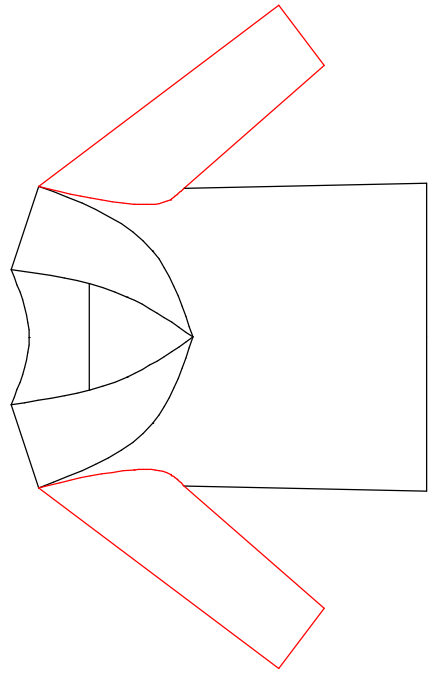
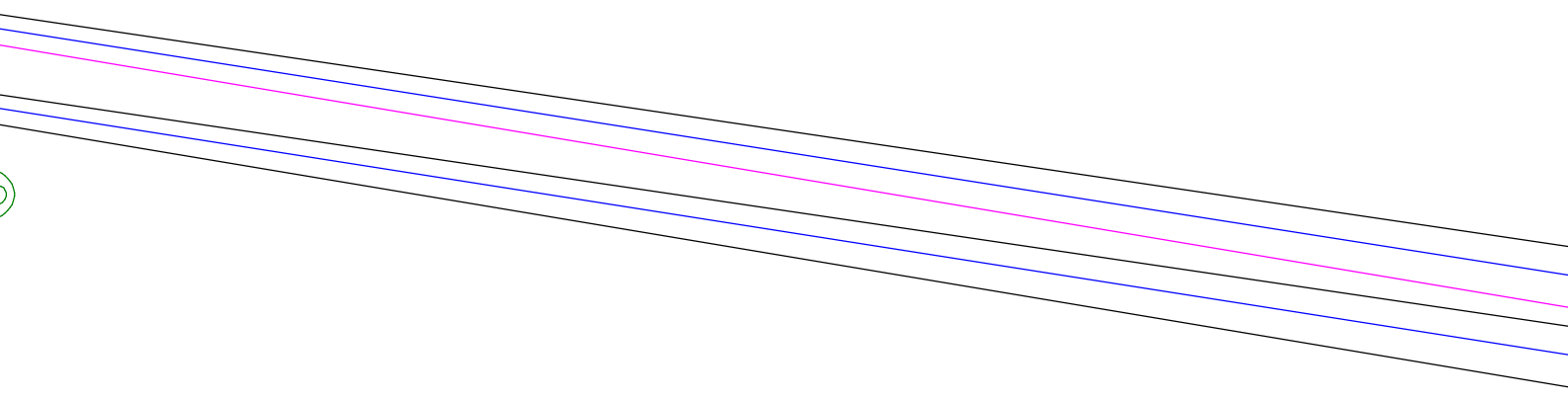
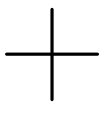
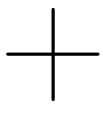

ここのパーツ

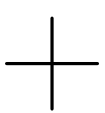
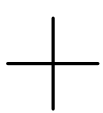

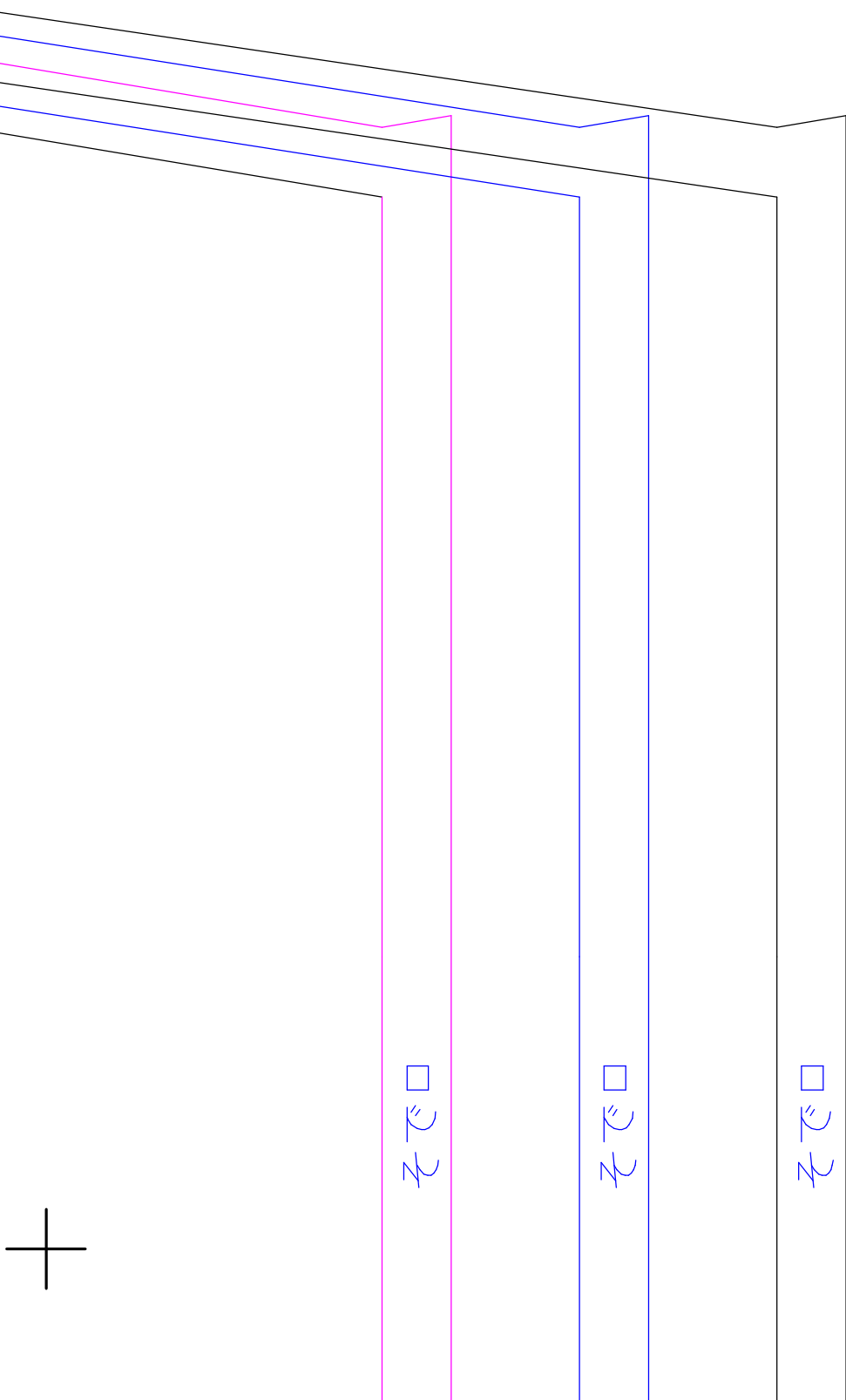
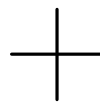
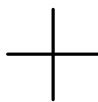

□<sub>1</sub>そ

□<sub>2</sub>そ

□<sub>3</sub>そ

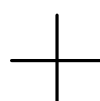
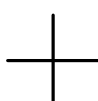

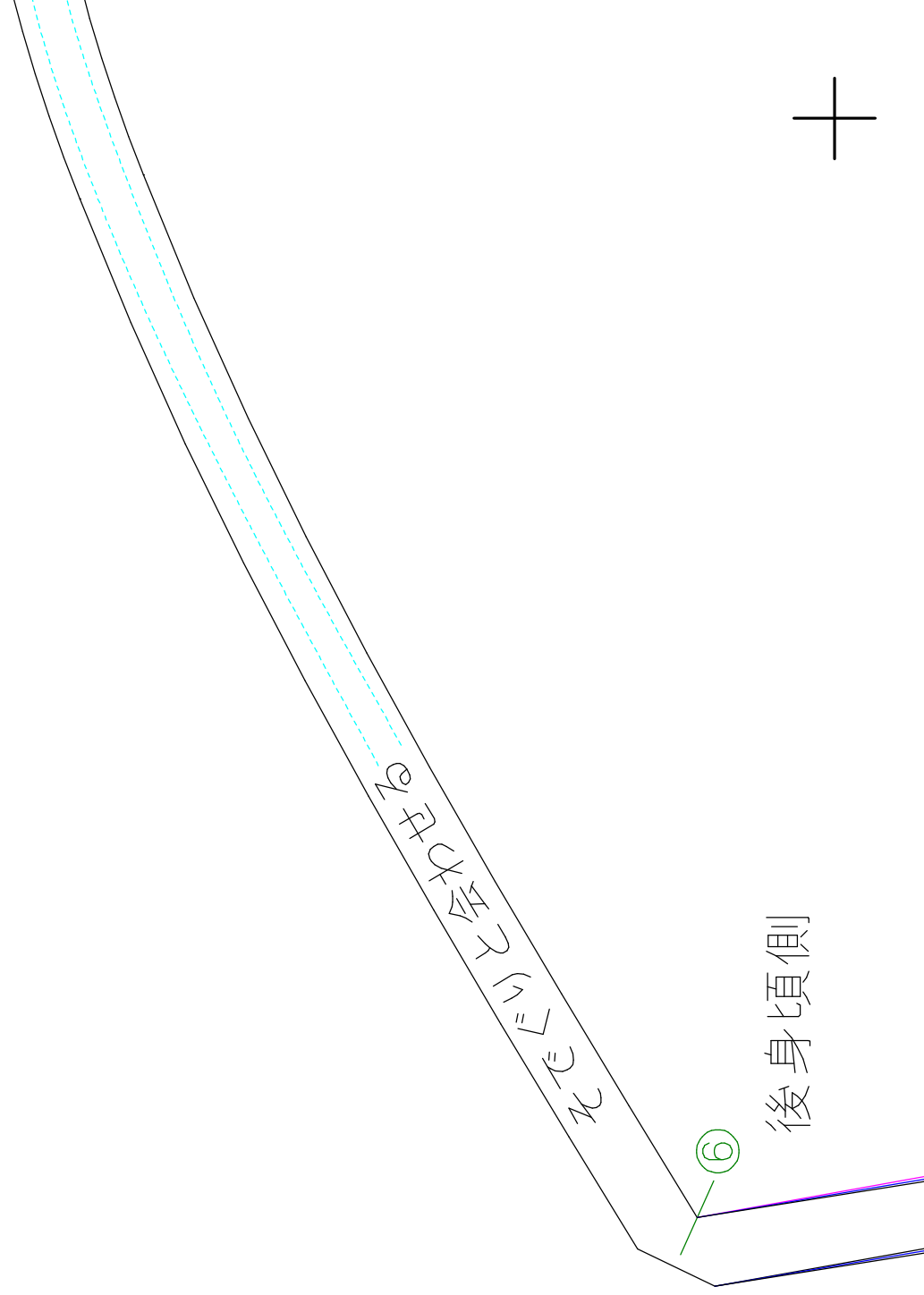
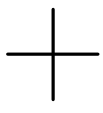

後身頃側

⑥

後身頃側

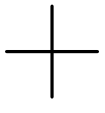
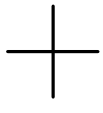

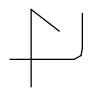
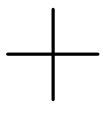

雙

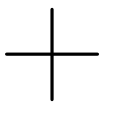

後身頭側

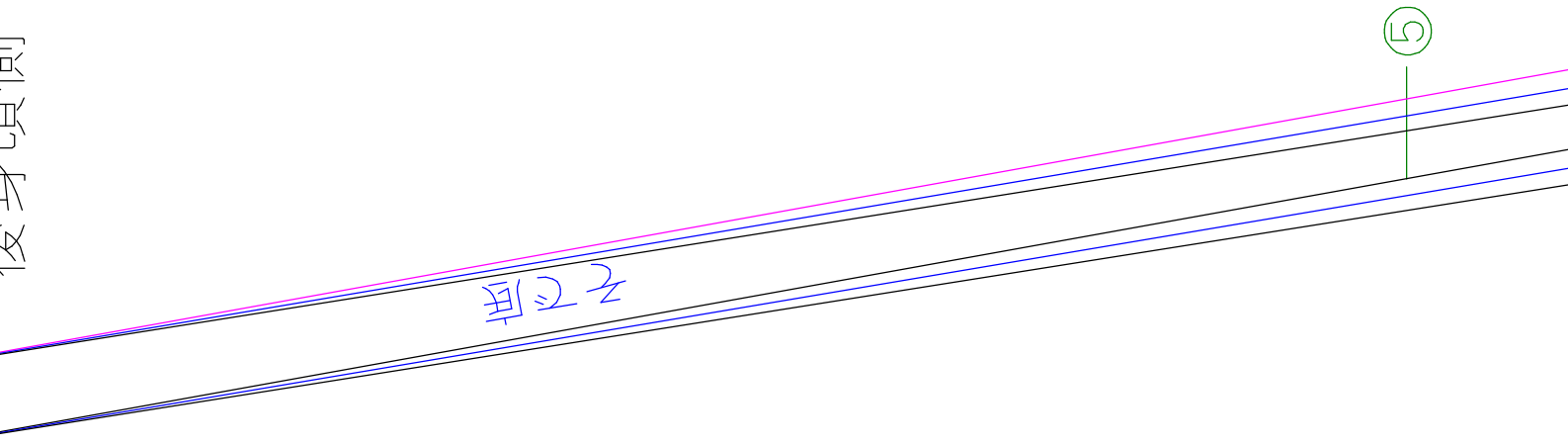

雙

5

